



## Parametric Instrument Accessories Guide

- Agilent B1500A—Semiconductor Device Analyzer
- Agilent 4155C/4156C—Semiconductor Parameter Analyzer
- Agilent E5270B—8 slot Precision Measurement Mainframe
- Agilent E5260A—8 slot High Speed Measurement mainframe
- Agilent B2200A—fA Leakage Switch Mainframe
- Agilent B2201A—14ch Low Leakage Switch Mainframe
- Agilent E5250A—Low Leakage Switch Mainframe



# Table of Contents

1. Introduction	<b>3</b>
2. Connecting to fixture	<b>4</b>
2.1. Jumper cables	<b>4</b>
2.2. Socket modules	<b>5</b>
3. Connecting to SWM	<b>6</b>
3.1. GNDU	<b>6</b>
3.2. SMU	<b>7</b>
4. Connecting to prober	<b>8</b>
4.1. GNDU connections	<b>8</b>
4.2. SMU/CMU connections	<b>9</b>
5. Accessories	<b>13</b>
5.1. CMU accessories	<b>13</b>
5.2. B1500A peripherals	<b>15</b>
5.3. Connector type	<b>16</b>
5.4. Cables	<b>18</b>
5.5. Connector plates	<b>20</b>
5.6. Adapters & connectors	<b>24</b>

# 1. Introduction

This guide provides information on how to connect a prober to Agilent Technologies semiconductor parametric measurement instruments.

This guide also provides information on accessories for a variety of Agilent Technologies semiconductor parametric measurement instruments, such as the B1500, B2200/B2201, E5250, E5260/E5270, 4155/4156, 41501.



Figure 1.1. B1500A with Cascade prober



Figure 1.2. B1500A with Vector prober



Figure 1.3. B1500A with Suss prober

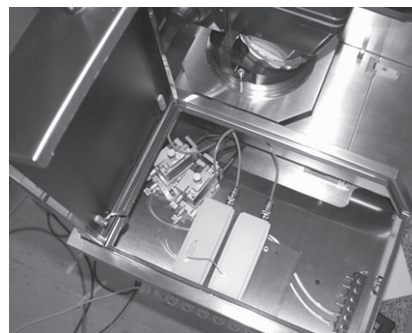

Figure 1.4. ASUs on the probe station

## 2. Connecting to Fixture

The 16442A and 16442B test fixtures have 6 triaxial input ports. You can connect force ports of SMU to them by using Triaxial Cable 16494A as shown in Figure 2.1.

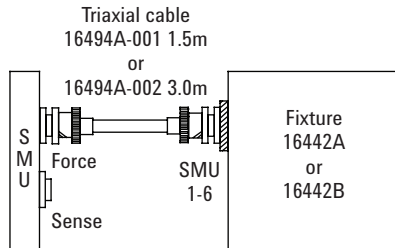

Figure 2.1. Connecting SMUs to fixture



### 2.1. Jumper cables

Table 2.1. Jumper cables

#### Mini banana – Pin plug

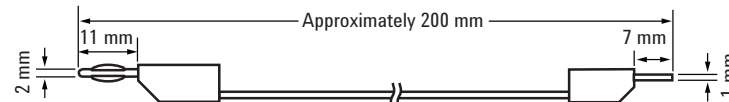

#### As option of 16442A/16442B

16442A-811/16442B-811 for Black (2ea), Blue (2ea), Red (2ea)

#### Parts number

16442-61600 for Black (1ea)

16442-61601 for Red (1ea)

16442-61602 for Blue (1ea)

#### Pin plug – Pin plug

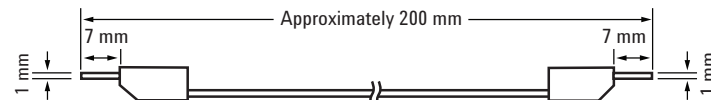

#### As option of 16442A/16442B

16442A-812/16442B-812 for Black (2ea), Blue (2ea), Red (2ea)

#### Parts number

16442-61603 for Black (1ea)

16442-61604 for Red (1ea)

16442-61605 for Blue (1ea)

#### Mini banana – Mini clip

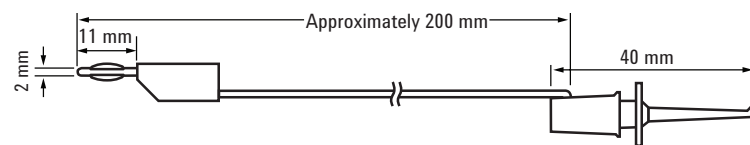

#### As option of 16442A/16442B

16442A-813/16442B-813 for Black (2ea), Blue (2ea), Red (2ea)

#### Parts number

16442-61606 for Black (1ea)

16442-61607 for Red (1ea)

16442-61608 for Blue (1ea)

#### Mini banana – Mini banana

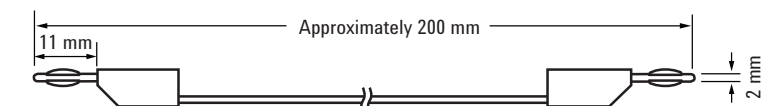

#### As option of 16442A/16442B

16442A-814/16442B-814 for Black (2ea), Blue (2ea), Red (2ea)

#### Parts number

16442-61609 for Black (1ea)

16442-61610 for Red (1ea)

16442-61611 for Blue (1ea)

## 2.2. Socket modules

Table 2.2. Socket modules

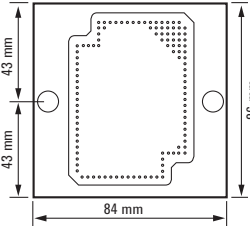
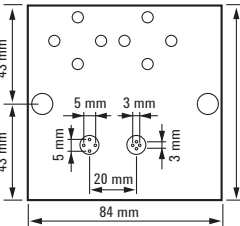
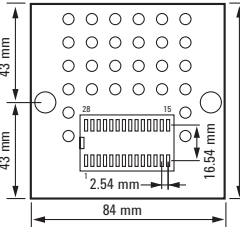
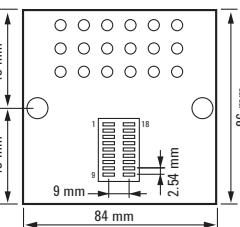
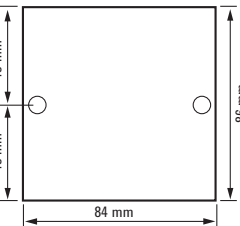
N1254A-204	0.1 inch	 <p>This socket module is for measurement of virtually any device—component, DIPIC, or small-scale circuit.</p>
16442A-801/16442B-801	0.1 inch	
N1254A-205	0.075 inch	
16442A-802/16442B-802	0.075 inch	
N1254A-206	0.05 inch	
16442A-803/16442B-803	0.05 inch	
N1254A-200		 <p>This socket module has two transistor sockets for measurement of three lead or four lead bipolar transistors and FETs.</p> <p>Maximum voltage: 200 V</p>
16442A-821/16442B-821		
N1254A-201		 <p>This socket module has a 28-pin dual-in-line socket.</p> <p>Maximum voltage: 230 V</p>
16442A-823/16442B-823		
N1254A-202		 <p>This socket module has an 18-pin dual-in-line socket.</p> <p>Maximum voltage: 230 V</p>
16442A-822/16442B-822		
N1254A-207		 <p>This insulation board has minimal leakage current, and so is good for extremely low current measurements.</p>
16442A-800/16442B-800		

# 3. Connecting to SWM

## 3.1. GNDU

An SMU has FORCE (SENSE), GUARD, and COMMON, but a GNDU has SENSE, FORCE, and COMMON as shown in Figure 3.1. You need some sort of GNDU to Kelvin adapter when connecting the GNDU to standard triaxial connections.

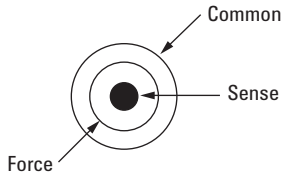

Figure 3.1. GNDU terminal

### CAUTION

You should use the Agilent 16493L GNDU cable to connect the GNDU to the SWM; do not use a standard triaxial cable. The GNDU cable can handle the maximum GNDU current of 4.2 A, but standard triaxial cables are only rated to 1 A.

#### (Non-Kelvin connection)

Connect the triaxial connector using an adapter for GNDU (N1254A-107) as shown in Figure 3.2. For this part, see Table 1.10 in Section 1.6 Adapters. For parts information, see Table 3.1.

#### Kelvin connection

Connect the dual triaxial connector using a GNDU to Kelvin Adapter (N1254A-100) as shown in Figure 3.3. For this part, see Table 1.10 in Section 1.6 Adapters. For parts information, see Table 3.2. Maximum current is restricted when the Kelvin triaxial cable is used. See Table 3.2.

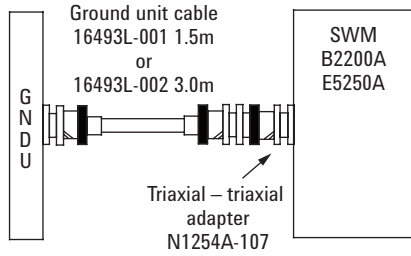

Figure 3.2. Examples of a GNDU non-Kelvin connection to SWM

Table 3.1. Parts information

Description	Qty	Part number	Product
Ground unit cable – 1.5m (Max 4.2A)	1	—	16493L-001
Ground unit cable – 3.0m (Max 4.2A)	1	—	16493L-002
Adapter for GNDU (triaxial (m) – triaxial (f))	1	1250-2654	N1254A-107

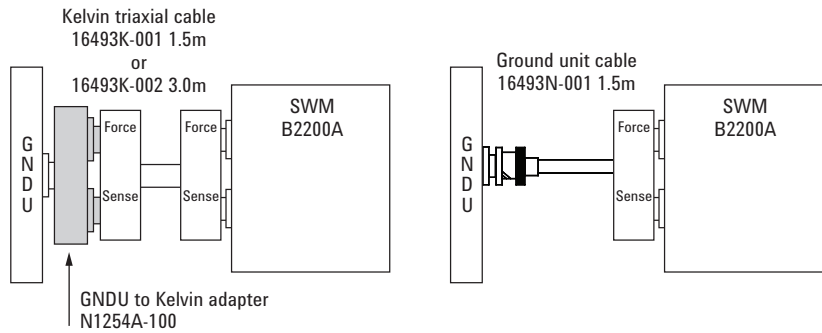

Figure 3.3. Examples of a GNDU Kelvin connection to SWM

Table 3.2. Parts information

Description	Qty	Part number	Product
Kelvin triaxial cable – 1.5m (Max 3.0A)	1	—	16493K-001
Kelvin triaxial cable – 3.0m (Max 2.6A)	1	—	16493K-001
Ground unit cable – 1.5m	1	—	16493N-001
GNDU to Kelvin adapter	1	—	N1254A-100

### 3.2. SMU

An SMU terminal is shown in Figure 3.4.

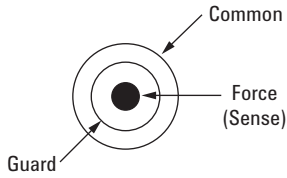

Figure 3.4. SMU terminal

#### Kelvin connection

When Kelvin connection is used, connect an Agilent 16493K Kelvin triaxial cable for B2200A/B2201A as shown in Figure 3.5. For E5250A, connect an Agilent 16494B Kelvin Triaxial Cable as shown in Figure 3.5. You can also use two Agilent 16494A triaxial cables in place of one Kelvin Triaxial Cable.

Connect the FORCE and SENSE lines to ports separately.

#### Non-kelvin connection

When non-Kelvin connection is used, connect the Agilent 16494A triaxial cable between the SMU and SWM as shown in Figure 3.6.

### 3.3. MFCMU

MFCMU of B1500A is connected to CMH and CML port of B2200A/ B2201A by using CMU input cable 16494F-001 as shown in Figure 3.7.

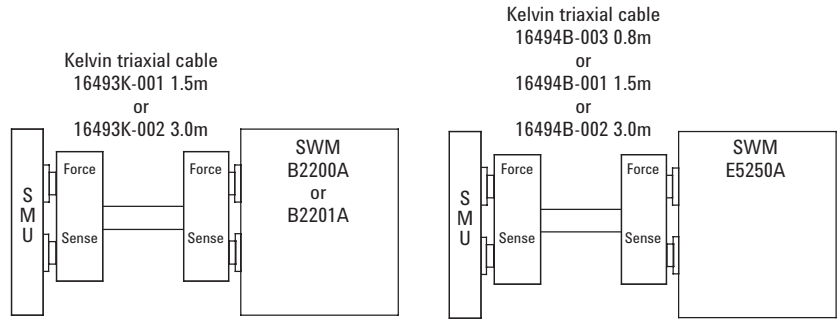

Figure 3.5. Examples of a SMU Kelvin connection to SWM

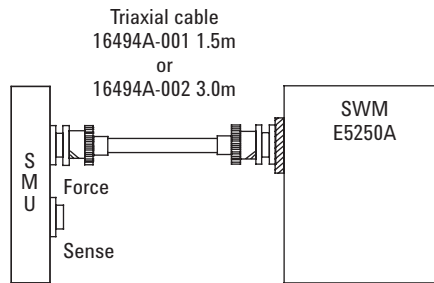

Figure 3.6. Examples of a SMU non-Kelvin connection to SWM

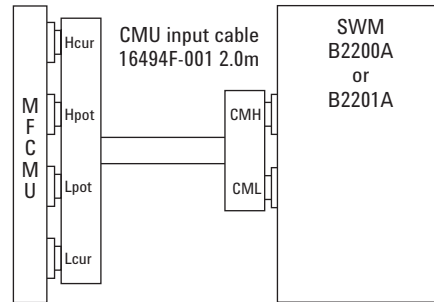

Figure 3.7. Examples of a MFCMU connection to SWM

# 4. Connecting to prober

## 4.1. GNDU connections

An SMU has FORCE (SENSE), GUARD, and COMMON, but a GNDU has SENSE, FORCE, and COMMON as shown in Figure 4.1. You need some sort of GNDU to Kelvin adapter when connecting the GNDU to standard triaxial connections.

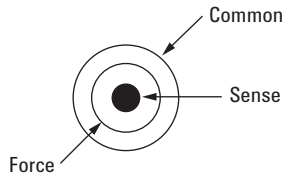

Figure 4.1. GNDU terminal

### CAUTION

You should use the Agilent 16493L GNDU cable to connect the GNDU to the connector plate; do not use a standard triaxial cable. The GNDU cable can handle the maximum GNDU current of 4.2A, but standard triaxial cables are only rated to 1 A.

### Non-Kelvin connection

Connect the triaxial connector using an adapter for GNDU (N1254A-107) as shown in Figure 4.2. For this part, see Table 5.10 in Section 5.6 Adapters. For parts information, see Table 4.1.

### Kelvin connection

Connect the dual triaxial connector using a GNDU to Kelvin Adapter (N1254A-100) as shown in Figure 4.3. For this part, see Table 5.10 in Section 5.6 Adapters. For parts information, see Table 4.2. Maximum current is restricted when the Kelvin triaxial cable is used. See Table 4.2.

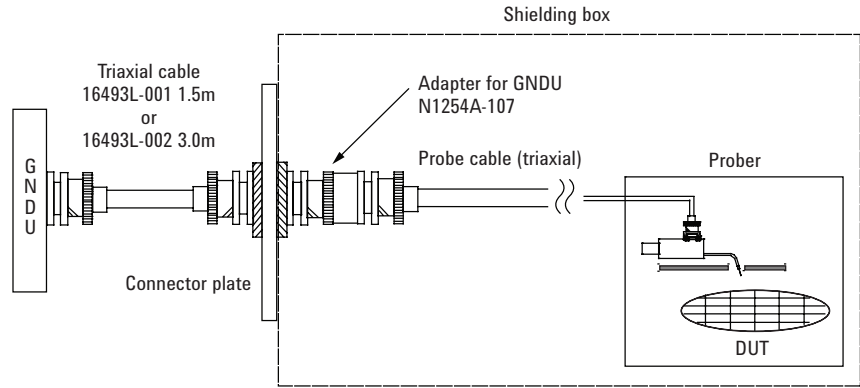

Figure 4.2. Examples of a GNDU non-Kelvin connection

Table 4.1. Parts information

Description	Qty	Part number	Product
Ground unit cable – 1.5m (Max 4.2A)	1	—	16493L-001
Ground unit cable – 3.0m (Max 4.2A)	1	—	16493L-002
Adapter for GNDU (triaxial (m) – triaxial (f))	1	1250-2654	N1254A-107

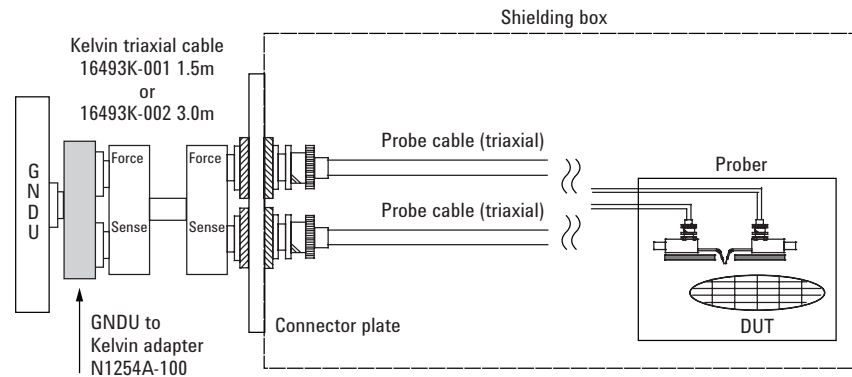

Figure 4.3. Examples of a GNDU Kelvin connection

Table 4.2. Parts information

Description	Qty	Part number	Product
Kelvin triaxial cable – 1.5m (Max 3.0A)	1	—	16493K-001
Kelvin triaxial cable – 3.0m (Max 2.6A)	1	—	16493K-002
GNDU to Kelvin adapter	1	—	N1254A-100



## 4.2. SMU/CMU connections

An SMU terminal is shown in Figure 4.4.

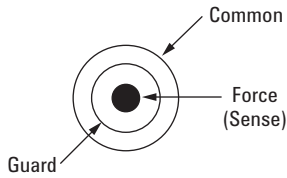

Figure 4.4. SMU terminal

### Kelvin connection

These instructions apply when all connections are Kelvin. Two probes must contact the wafer in this connection.

Connect an Agilent 16493K Kelvin triaxial cable (or two Agilent 16494A triaxial cables) between the SMU and the connector plate. Connect the FORCE and SENSE lines to probes separately. Connect the triaxial connector on the probe cable as shown in Figure 4.5. To prevent oscillations, use short cables. For parts information, see Table 4.3.

### Non-kelvin connection

These instructions apply when all connections are non-Kelvin. Connect the Agilent 16494A triaxial cables between the SMU and the Connector plate.

Connect the triaxial connector on the probe cable as shown in Figure 4.6. For parts information, see Table 4.4.

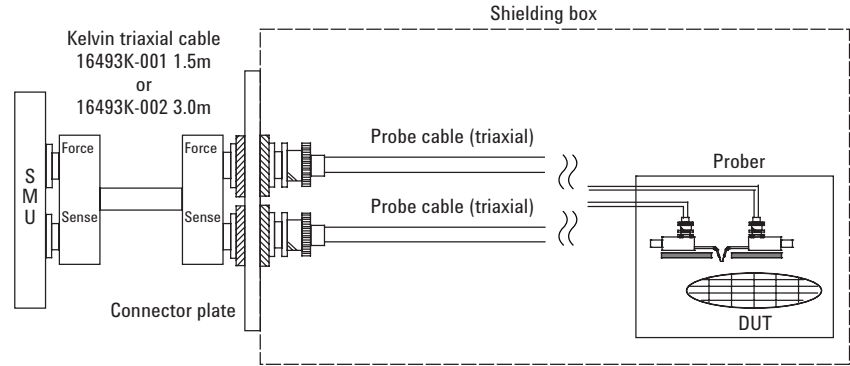

Figure 4.5. Examples of a SMU Kelvin connection

Table 4.3. Parts information

Description	Qty	Part number	Product
Kelvin triaxial cable – 1.5m (Max 3.0A)	1	—	16493K-001
Kelvin triaxial cable – 3.0m (Max 2.6A)	1	—	16493K-002

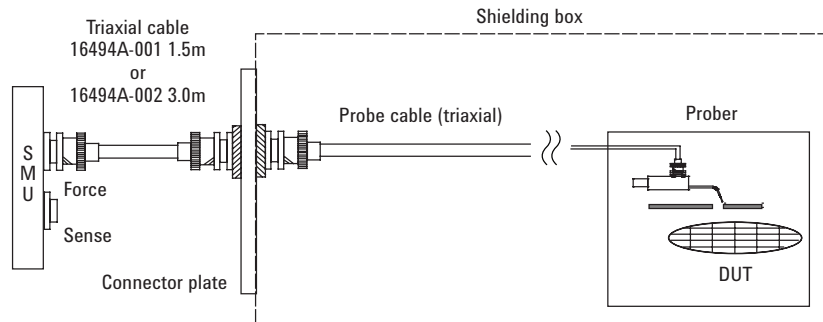

Figure 4.6. Examples of a SMU non-Kelvin connection

Table 4.4. Parts information

Description	Qty	Part number	Product
Triaxial cable – 1.5m	1	—	16494A-001
Triaxial cable – 3.0m	1	—	16494A-002

### Kelvin to non-kelvin connection

These instructions apply when the connections up to the Connector Plate are Kelvin, but the probe is a non-Kelvin connection.

Connect an Agilent 16493K Kelvin triaxial cable (or two Agilent 16494A triaxial cables) between the SMU and the Connector plate.

Connect the triaxial connector on the probe cable as shown in Figure 4.7.

Connect the FORCE and SENSE lines on this side of the probe input terminal. A Tee Triaxial BNC adapter can be used. For parts information, see Table 4-5.

**Note:**

When connecting the cable and tee connector as shown in Figure 4.7, space restrictions make an adjacent connector unusable. Since three connectors are necessary for a Kelvin connection a connector plate must be used. Select the correct connector plate for your application. To make two Kelvin connections, use an Agilent 16495H. To make three Kelvin connections, use an Agilent 16495J.

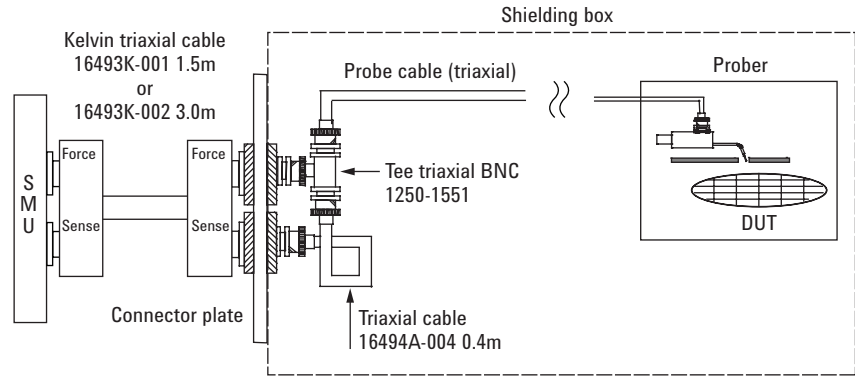

Figure 4.7. Examples of a SMU Kelvin to non-Kelvin connection

Table 4.5. Parts information

Description	Qty	Part number	Product
Kelvin triaxial cable – 1.5m	1	—	16493K-001
Kelvin triaxial cable – 1.5m	1	—	16493K-002
Triaxial cable – 0.4m	1	—	16494A-004
Triaxial tee-connector	1	1250-1551	—

## ASU connection

Each ASU has one Dsub control cable, one triaxial cable, and (optionally) two coaxial cables connected to it. The cables can be connected to the ASU inside the shielding box through the 16495K plate.

The ASU outputs should be connected to the DUT by using triaxial cables as shown in Figure 4.8.

When making IV measurements with the SMUs, all measurements are Kelvin. The SENSE line information is fed back to the SMU via the Dsub cable.

When making CV measurements, the four-terminal pair (4TP) connections are correctly terminated inside of the ASUs. The ASUs also allow for a current return path between the outer conductors to stabilize the series inductance and improve accuracy. You must connect the furnished wire between the two ASUs to enable this feature.

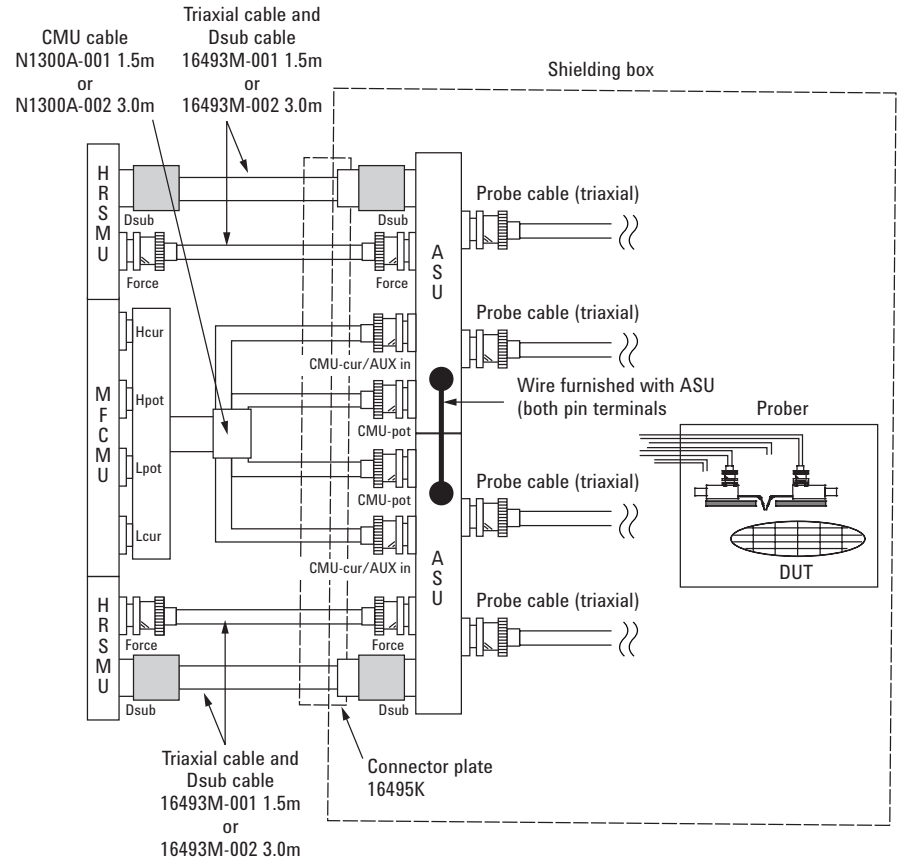

Figure 4.8. Examples of an ASU connection

Table 4.5. Parts information

Description	Qty	Part number	Product
Triaxial cable & Dsub cable for ASU – 1.5m	2	—	16493M-001
Triaxial cable & Dsub cable for ASU – 3.0m	2	—	16493M-002
CMU cable for B1500A – 1.5m	1	—	N1300A-001
CMU cable for B1500A – 3.0m	1	—	N1300A-002
Connector plate	1	—	16495K

### SCUU positioner-based probing mode

The SCUU should be connected to the DUT by using triaxial cables as shown in Figure 4.9.

When making IV measurements using the SMUs, the outputs of the SCUU function exactly the same as the Kelvin outputs of an SMU (both FORCE and SENSE lines are available).

Note: In Figure 4.9 the SENSE lines are not used.

When making CV measurements using the MFCMU, only the FORCE outputs of the SCUU are used. SCUU FORCE output1 corresponds to CMH, and SCUU FORCE output2 corresponds to CML.

The SCUU can be fixed on the prober by using SCUU Magnet Stand (N1301A-110).

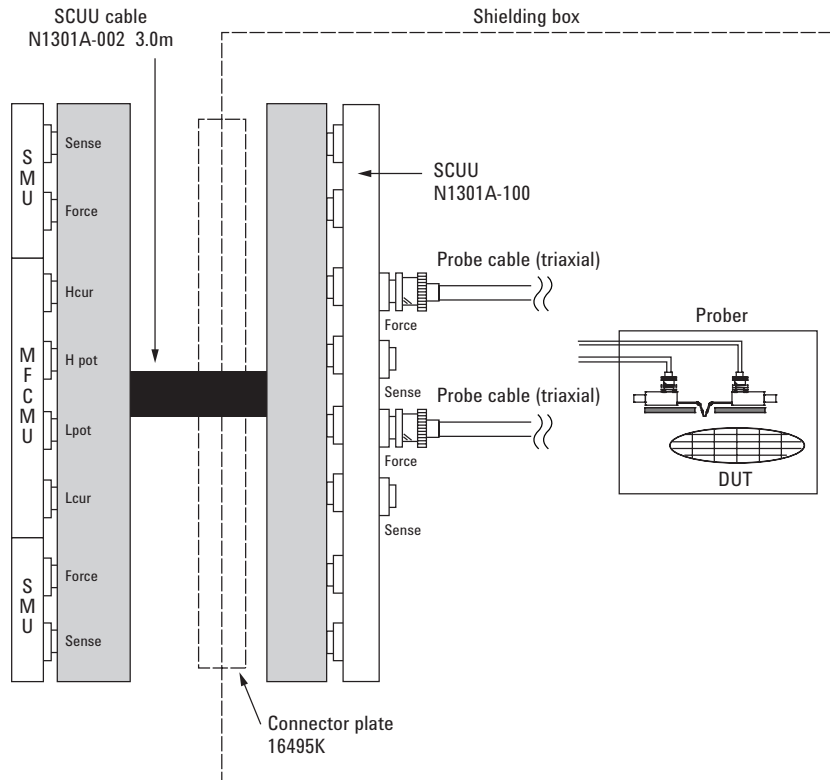

Figure 4.9. Examples of a SCUU remote docking mode

Table 4.9. Parts information

Description	Qty	Part number	Product
SMU CMU unify unit (SCUU)	1	—	N1301A-100
SMU CMU unify unit cable (3.0m)	1	—	N1301A-102
Connector plate	1	—	16495K

## 5. Accessories

### 5.1 CMU accessories

B1500A has the multi frequency capacitance measurement unit (MFCMU). There are two types of CMU connection as follows.

- Standard four terminal pair (4TP) connection
- SCUU positioner-based probing mode

According to your situation, you can select the type of connection.

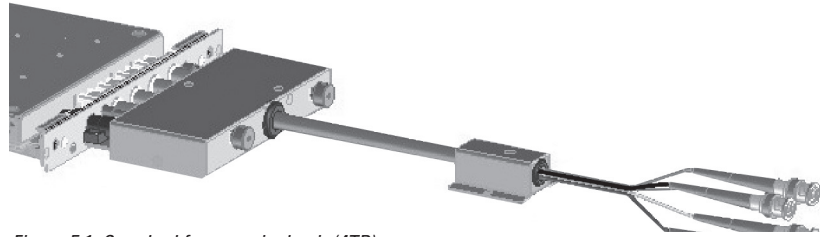

Figure 5.1. Standard four terminal pair (4TP)

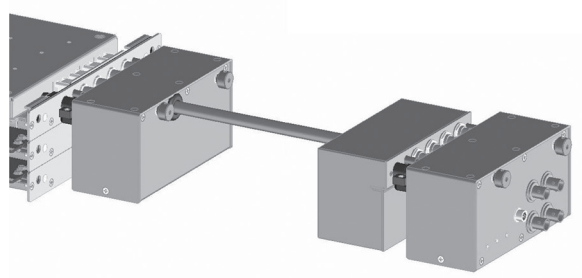
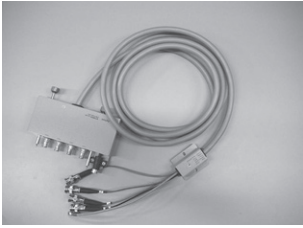

Figure 5.2. SCUU positioner-based probing

Table 5.1. CMU accessories overview

N1300A-001/N1300A-002



16494F-001



N1301A-100

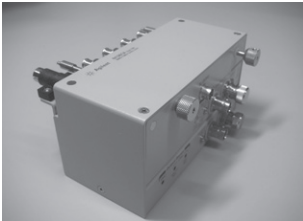

N1301A-100



N1301A-100



N1301A-102

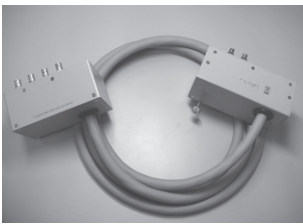

SCUU w/SCUU Cable, GSWU

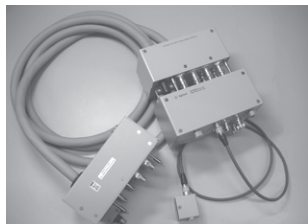

N1301A-110



SCUU w/SCUU magnet



N1301A-200



N1301A-201



Pin cable for GSWU



GSWU w/GSWU cable



Table 5.2. CMU accessories item list

Item	Description	OP instruction
N1300A	CMU cable for B1500A	
N1300A-001	CMU cable for B1500A (1.5m)	
N1300A-002	CMU cable for B1500A (3.0m)	
N1301A	CMU accessories for B1500	
N1301A-100	SMU CMU unify unit (SCUU)	
N1301A-102	SMU CMU unify unit cable (3m)	
N1301A-110	SCUU magnet stand	To fix SCUU on prober top etc.
N1301A-200	Guard switch unit (GSWU)	Need to be specified with N1301A-201 or N1301A-202.
N1301A-201	Guard switch unit cable (1m)	Please specify N1301A-201 or N1302A-202 when N1301A-200 is ordered.
N1301A-202	Guard switch unit cable (3m)	
16494F	CMU input cable	
16494F-001	CMU input cable (2m)	

## 5.2. B1500A peripherals

Table 5.3. B1500A peripherals overview

16444A-001



16444A-002



16444A-001 16444A-003



Table 5.4. B1500A peripherals item list

Item	Description	OP instruction
16444A	B1500A accessories	
16444A-001	USB keyboard	Keyboard includes mouse pad and mouse pointer
16444A-002	USB mouse	USB Mouse
16444A-003	Stylus pen	For use with the B1500A touch screen

### 5.3. Connector type

There are two main styles of Kelvin SMU connections. When connecting instruments together, you need to make sure that you have the correct type of Kelvin triaxial cables.

Type A connectors have two screws, one guide pin, and two triaxial terminals. Type B connectors have one screw and two triaxial terminals. These connectors are also different in their width and thickness.

Table 5.5. Overview of instrument connector types

#### B1500A



#### Type A



#### 4156C+41501B



#### Type A

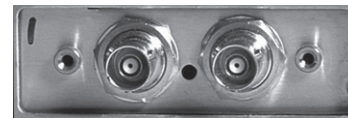

#### 4155C



#### Single triaxial



#### E5260A/E5270B

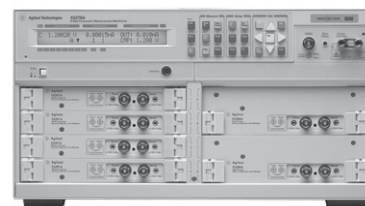

#### Type A



#### B2200A/B2201A inputs

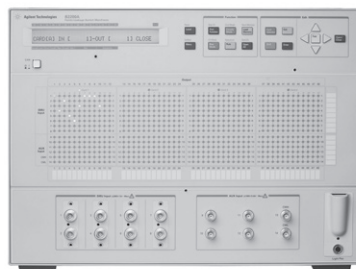

#### Type A



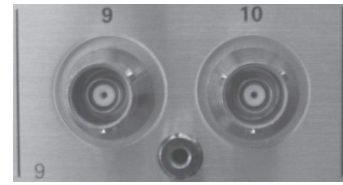

Table 5.5. Overview of instrument connector types. (continued)

B2200A/B2201A outputs



Type B



E5250A inputs



Type B



E5250A outputs (E5252A cards)



Type B

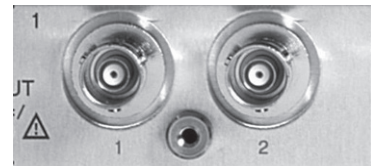

16442A/B



Type A



16493K/16494B/16493N cables

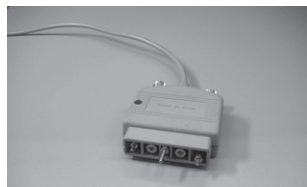

Type A



16494B cable



Type B



## 5.4. Cables

Several possibilities exist for connecting the Source Monitor Units (SMUs) to the DUT. The great variety of available cables can be categorized into mainly three types:

Triaxial cables have three layers or leads: a center conductor for the signal, a middle conductor that is actively driven to be at the same potential as the center conductor to eliminate leakage currents, and a grounded (Common) outer conductor.

Kelvin triaxial cables are similar to triaxial cables, except that both the Force and Sense lines from the SMU run through the same cable. The Force and Sense lines share a common driven guard and a common outer shield. Kelvin triaxial cables typically give better low-current measurement performance than you would get from using two separate triaxial cables for the Force and Sense lines.

The GNDU cable is a special triaxial cable designed to handle the large currents (up to 4.2 A) that the ground unit can sink. In the GNDU cable the center conductor is SENSE, the middle conductor is FORCE, and the outer conductor is Common.

Table 5.6. SMU cables overview

Connector type		Type A	Type A	Type B
SMU	B1500A	OK	OK	NG
	E526X	OK	OK	NG
	E527X	OK	OK	NG
	415X	OK	OK	NG
	41501	OK	OK	NG
SWM input	B220XA	OK	OK	NG
	E5250A	NG	NG	OK
SWM output	B220XA	NG	NG	OK
	E5250A	NG	NG	OK
Length option	0.4m	N/A	N/A	
	0.8m	N/A	16494B-003	
	1.5m	16493K-001	16494B-001	
	3.0m	16493K-002	16494B-002	
	4.0m	N/A	N/A	

16493K



Kelvin triaxial cable

16494B





Kelvin triaxial cable

Table 5.6. SMU cables overview, (continued)

		16493M	16494A	16493J
				
		Triaxial & Dsub cable For ASU	Triaxial cable	Interlock cable
Connector type		—	Triax	—
SMU	B1500A	OK	OK	OK
	E526X	N/A	OK	OK
	E527X	OK	OK	OK
	415X	N/A	OK	OK
	41501	N/A	OK	N/A
SWM input	B220XA	N/A	OK	N/A
	E5250A	N/A	OK	N/A
SWM output	B220XA	N/A	OK	N/A
	E5250A	N/A	OK	N/A
Length option	0.4m	N/A	16494A-004	N/A
	0.8m	N/A	16494A-003	N/A
	1.5m	16493M-001	16494A-001	16493J-001
	3.0m	16493M-002	16494A-002	16493J-002
	4.0m	N/A	16494A-005	N/A

Table 5.7. GNDU cables overview

		16493N	16493L
			
		Ground unit cable	Ground unit cable
Connector type		Type A	Triaxial
GNDU	B1500A	N/A	OK
	E526X	N/A	OK
	E527X	N/A	OK
	415X	N/A	N/A
	41501	N/A	OK
SWM input	B220XA	OK	OK
	E5250A	NG	OK
SWM output	B220XA	NG	OK
	E5250A	NG	OK
Length option	1.5m	16493N-001	16493L-001
	3.0m	N/A	16493L-002

## 5.5. Connector plates

The following connector plates work with a variety of Agilent Technologies semiconductor parametric measurement instruments, such as the B1500, B2200/B2201, E5250, E5260/E5270, 4155/4156 and 41501.

Prober vendor also provides connector plates. If you need the information of those connector plates, please kindly contact each prober vendor.

If you need parts to fix a connector plate, see Table 5.8. Order the quantity you need. (The number of holes in a connector plate is four.)

Table 5.8. Parts information to fix connector plates

Description	Qty	Part number	Product
Screw	1	0515-0986	---
Spring washer	1	2190-0584	---
Terminal washer	1	3050-0891	---
Nut	1	0535-0031	---

Table 5.9. Connector plates

### 16495F—Half size connector plate for matrix

16495F-001 has 12 triaxial through connectors (female to female), an Intlk connector, and a GNDU connector (triaxial through, female to female). The back of the Intlk connector is designed for soldering.

16495F-002 has 12 triaxial connectors, an Intlk connector, and a GNDU connector. The back of each connector is designed for soldering.



### 16495G—Full size connector plate for matrix

16495G-001 has 24 triaxial through connectors (female to female), an Intlk connector, and a GNDU connector (triaxial through, female to female). The back of the Intlk connector is designed for soldering.

16495G-002 has 24 triaxial connectors, an Intlk connector, and a GNDU connector. The back of each connector is designed for soldering.

### 16495H—Half size connector plate for analyzer

16495H-001 has 6 triaxial through connectors (female to female), 6 BNC through connectors (female to female), an Intlk connector, and a GNDU connector (triaxial through, female to female). The back of the Intlk connector is designed for soldering.

16495H-002 has 6 triaxial connectors, 6 BNC connectors, an Intlk connector, and a GNDU connector. The back of each connector is designed for soldering.



### 16495J—Half size connector plate for analyzer

16495J-001 has 8 triaxial through connectors (female to female), 4 BNC through connectors (female to female), an Intlk connector, and a GNDU connector (triaxial through, female to female). The back of the Intlk connector is designed for soldering.

16495J-002 has 8 triaxial connectors, 4 BNC connectors, an Intlk connector, and a GNDU connector. The back of each connector is designed for soldering.



### 16495K—Half size connector plate with universal cable holder

16495K-001 does not have any connectors. This plate provides the cable hole and the cover with rubber used to block the light from the cable hole. This plate will be used with the Agilent E5288A Atto Sense/Switch Unit (ASU) or the

Agilent N1301A-200 Guard Switch Unit (GSWU) that will be installed in the shielding box. The cable hole is to pass the cables from the ASU or GSWU to the instrument such as the Agilent B1500A, E5270B, and so on. And the cables will be fixed to the shielding box by using the cover with rubber that will close the opening of the cable hole.

A. Front view

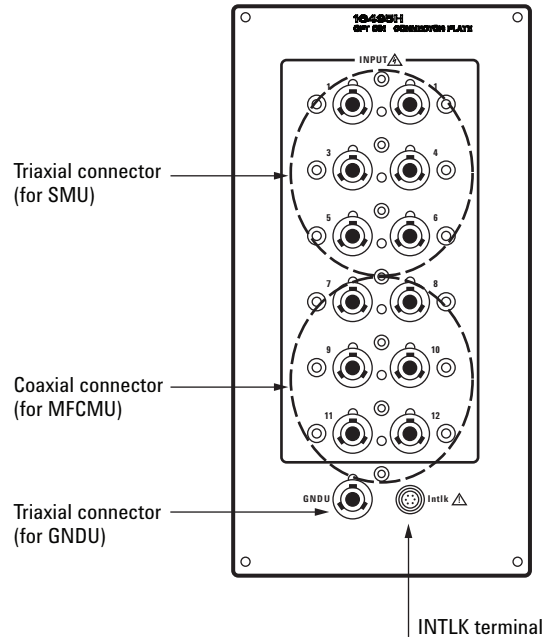
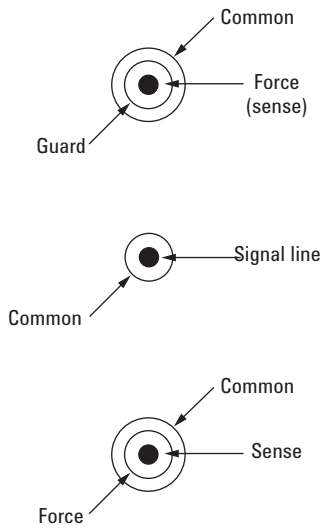

B. Rear view

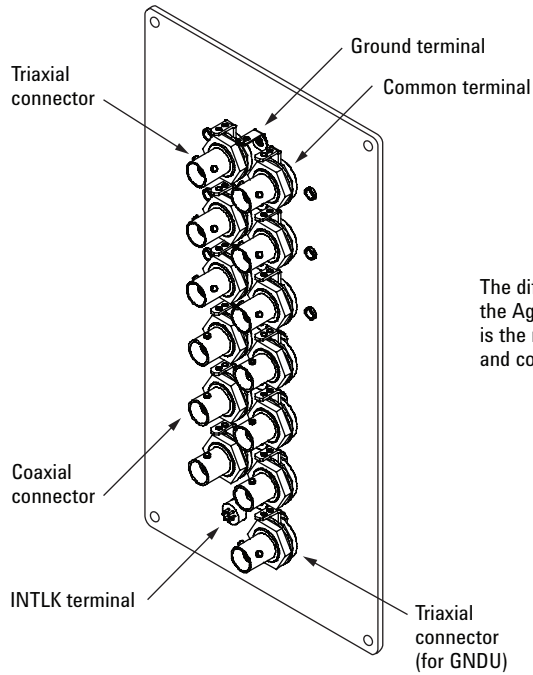

Agilent 16495H-001

The difference between the Agilent 16495F, H and J is the number of the triaxial and coaxial connectors.

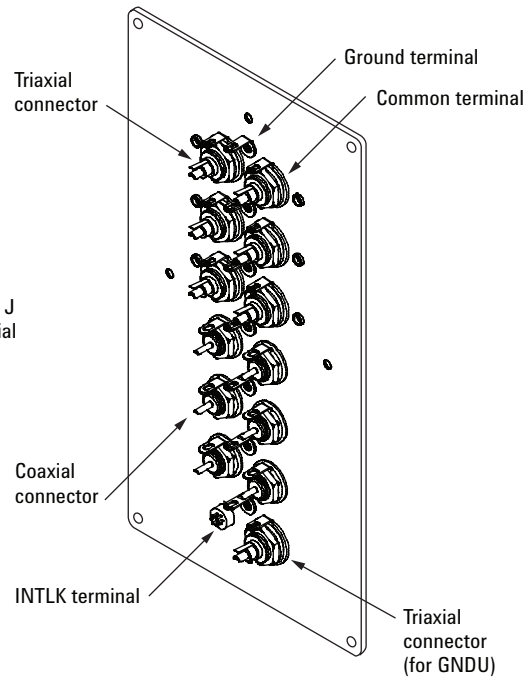

Agilent 16495H-002

Figure 5.3. Front view and rear view of connector plate

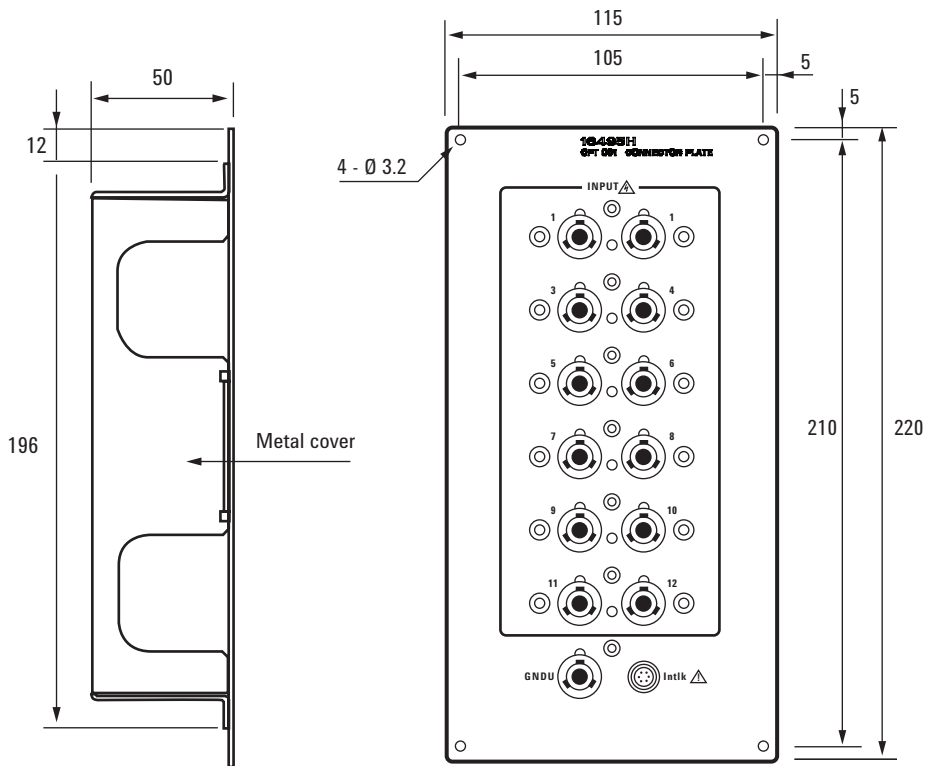

Unit: mm

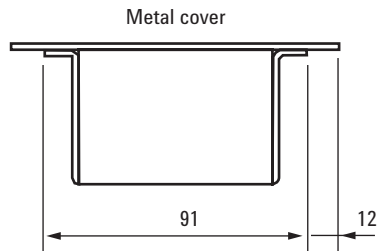

**Agilent 16495H-002**

(The difference between the Agilent 16495 F, H and J is the number of the triaxial and coaxial connectors.)

Note: Metal cover is for preventing electrical shock. Metal cover is furnished with 16495 F/G/H/J-002 only.

Figure 5.4. Dimensions of the connector plate (Agilent 16495F/H/J)

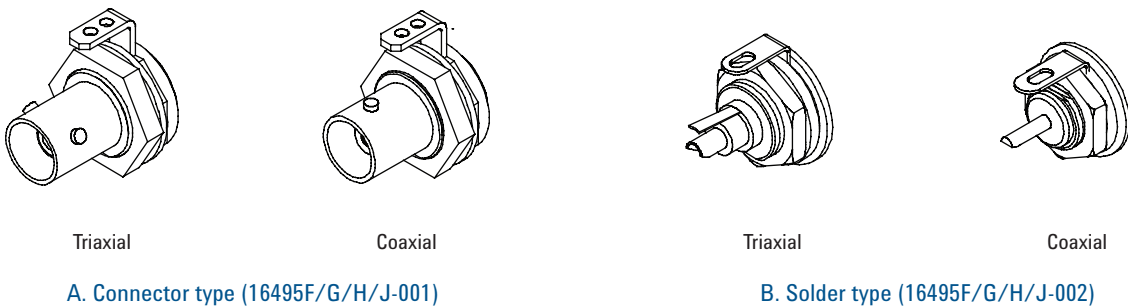
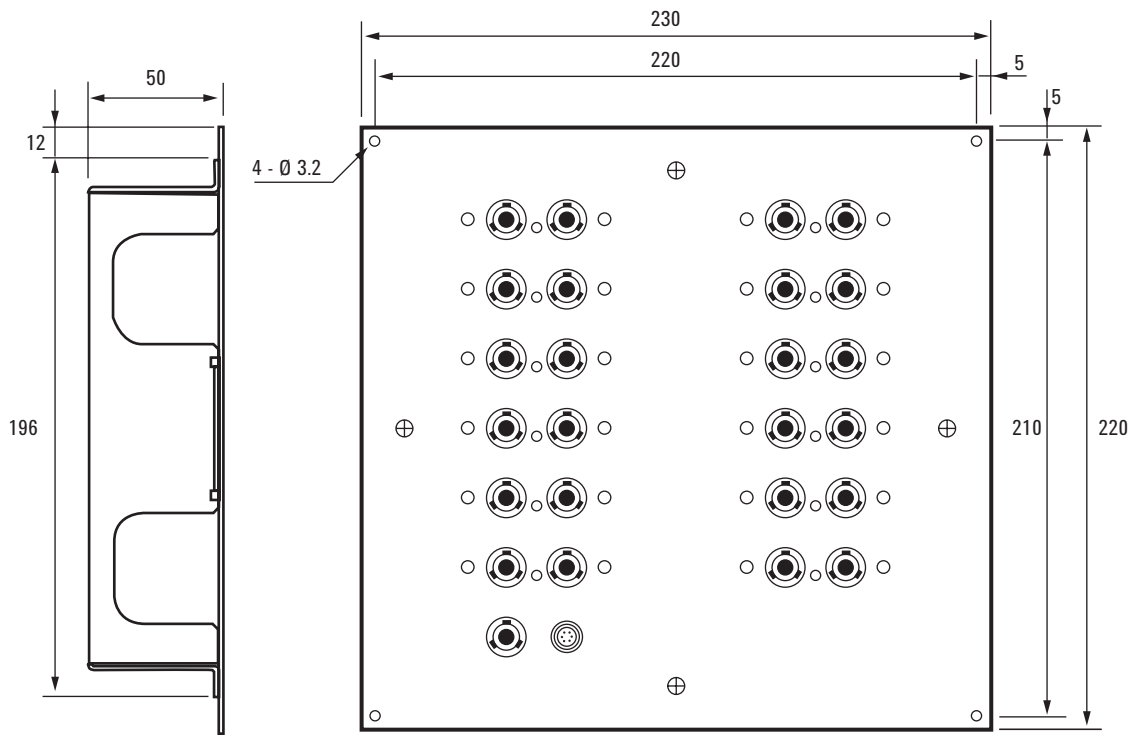

Figure 5.5. Connection type of connector plate (rear)



Unit: mm

Figure 5.6. Dimensions of the connector plate (Agilent 16495G)

## 5.6. Adapters and connectors

If you need to make a connection between a triaxial connector and a coaxial connector, use a triaxial-coaxial adapter.

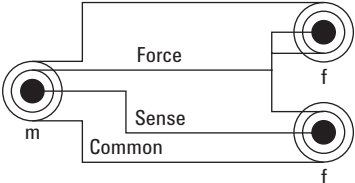

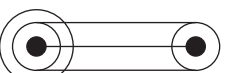

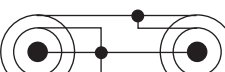



Table 5.10 shows the adapter information provided by Agilent. If you need an adapter which is not provided, contact a local parts vendor.

### WARNING

Be sure to use a shielding box and Interlock when you make a measurement.

Do not use the adapters in Table 5.10 when the GUARD line connects to the outer conductor of the connector or adapter. Because they connect GUARD line and outer conductor of the connector or adapter, the potential of the GUARD terminal is equal to the output voltage and there is a potential for high voltage electrical shock at the adapter and connector.

Table 5.10. Parts information

Item	Description	Qty	Part number	Illustration
N1254A-100	GNDU to Kelvin adapter	1	—	
N1254A-101	Triaxial (m) – Coaxial (f)	1	1250-2648	
N1254A-102	Triaxial (f) – Coaxial (m)	1	1250-2649	
N1254A-103	Triaxial (m) – Coaxial (f)	1	1250-2650	
N1254A-104	Triaxial (f) – Coaxial (m)	1	1250-2651	
N1254A-105	Triaxial (f) – Coaxial (m)	1	1250-2652	
N1254A-106	Triaxial (m) – Coaxial (f)	1	1250-2653	
N1254A-107	Triaxial (m) – Triaxial (f)	1	1250-2654	



Agilent B2900A Series Precision Source/Measure Unit  
[www.agilent.com/find/B2900A](http://www.agilent.com/find/B2900A)



Agilent B1500A Semiconductor Device Analyzer  
[www.agilent.com/find/B1500A](http://www.agilent.com/find/B1500A)



Agilent B1505A Power Device Analyzer/Curve Tracer  
[www.agilent.com/find/B1505A](http://www.agilent.com/find/B1505A)

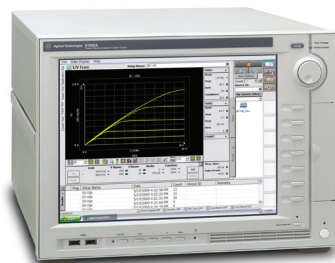

[www.agilent.com](http://www.agilent.com)  
[www.agilent.com/find/b1500A](http://www.agilent.com/find/b1500A)

For more information on Agilent Technologies' products, applications or services, please contact your local Agilent office. The complete list is available at:  
[www.agilent.com/find/contactus](http://www.agilent.com/find/contactus)

**Americas**

Canada	(877) 894 4414
Brazil	(11) 4197 3600
Mexico	01800 5064 800
United States	(800) 829 4444

**Asia Pacific**

Australia	1 800 629 485
China	800 810 0189
Hong Kong	800 938 693
India	1 800 112 929
Japan	0120 (421) 345
Korea	080 769 0800
Malaysia	1 800 888 848
Singapore	1 800 375 8100
Taiwan	0800 047 866
Other AP Countries	(65) 375 8100

**Europe & Middle East**

Belgium	32 (0) 2 404 93 40
Denmark	45 45 80 12 15
Finland	358 (0) 10 855 2100
France	0825 010 700*
	*0.125 €/minute
Germany	49 (0) 7031 464 6333
Ireland	1890 924 204
Israel	972-3-9288-504/544
Italy	39 02 92 60 8484
Netherlands	31 (0) 20 547 2111
Spain	34 (91) 631 3300
Sweden	0200-88 22 55
United Kingdom	44 (0) 118 927 6201

For other unlisted countries:

[www.agilent.com/find/contactus](http://www.agilent.com/find/contactus)

(BP-09-27-13)

Product specifications and descriptions in this document subject to change without notice.

© Agilent Technologies, Inc. 1998-2013  
 Published in USA, December 29, 2013  
 5989-5695EN



**myAgilent**

[www.agilent.com/find/myagilent](http://www.agilent.com/find/myagilent)

A personalized view into the information most relevant to you.



**Three-Year Warranty**

[www.agilent.com/find/ThreeYearWarranty](http://www.agilent.com/find/ThreeYearWarranty)

Beyond product specification, changing the ownership experience. Agilent is the only test and measurement company that offers three-year warranty on all instruments, worldwide.



**Agilent Assurance Plans**

[www.agilent.com/find/AssurancePlans](http://www.agilent.com/find/AssurancePlans)

Five years of protection and no budgetary surprises to ensure your instruments are operating to specifications and you can continually rely on accurate measurements.



[www.agilent.com/quality](http://www.agilent.com/quality)



Agilent Electronic Measurement Group  
 DEKRA Certified ISO 9001:2008  
 Quality Management System

**Agilent Channel Partners**

[www.agilent.com/find/channelpartners](http://www.agilent.com/find/channelpartners)

Get the best of both worlds: Agilent's measurement expertise and product breadth, combined with channel partner convenience.



**Agilent Technologies**